

RoHS Compliant

Halogen Free

customer drawing

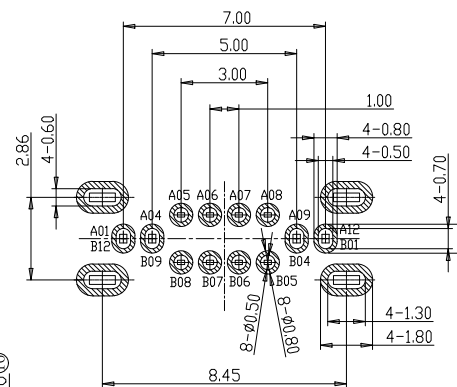
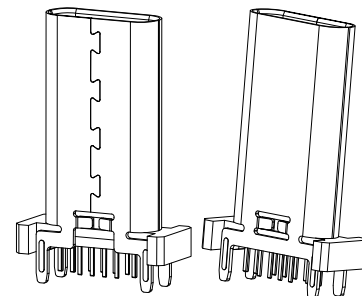
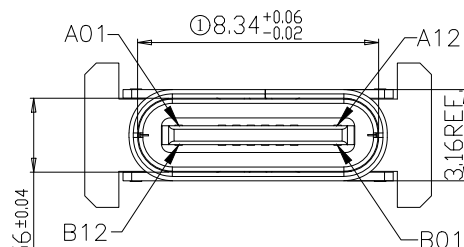

特性:

- 一、电气性能: ELECTRICAL
- 1. 额定电流: 5.0A
- 2. 接触阻抗: 40 MILLIOHMS MAX
- 3. 耐电压: 150V AC / 1 mA MAX
- 4. 绝缘阻抗: 150V DC/100 MEGA OHMS MIN

二、机械性能:

- 1. 插入力: 5~20N
- 2. 拔出力: 8~20N
- 3. 使用寿命: 10000次、拔出力 5N MIN

三、材料: MATERIAL

- 1. 塑胶: LCP/PA9T UL94V-0
- 2. 端子: C7025/C1814 T=0.15MM
- 3. 外壳: SUS304 T=0.30MM
- 4. 卡勾: SUS304 T=0.15MM

四、电镀: FINISH

- 1. 端子: 接触点镀金3U"MIN
PIN脚焊接区域镀金1U"MIN.
- 2. 外壳: 镀镍80U"MIN (盐雾48H)
- 五、电镀品需做粘锡测试: 粘锡面积达到95%以上.
- 六、SMT回流焊 (峰值260° C±5° C) 不能起泡、熔胶、变色不良 (变形在公差范围以内)
- 七、工作温度: -55° C~+85° C
- 八、盐雾测试: 通过48H在浓度为5±1%盐水的盐雾测试无生锈现象

RECOMMENDED P.C.B. LAYOUT (俯视图)
TOLERANCE UNSPECIFIED ±0.05mm

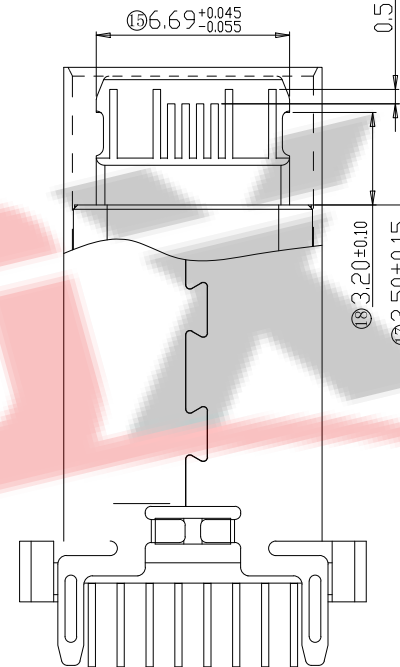
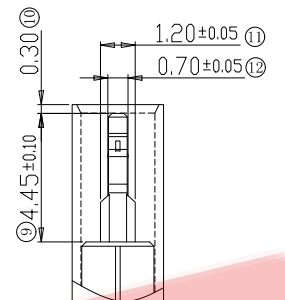
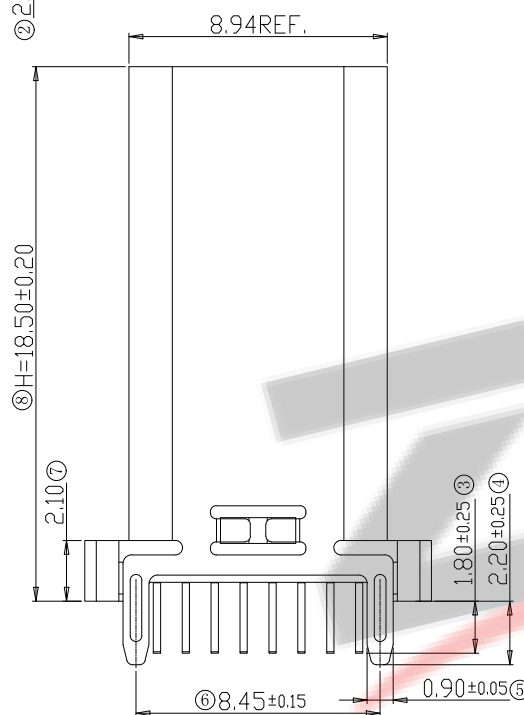

剖视图

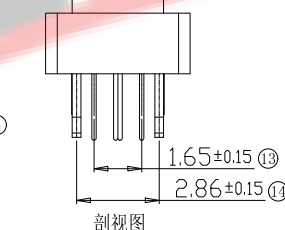

剖视图

料号编码:

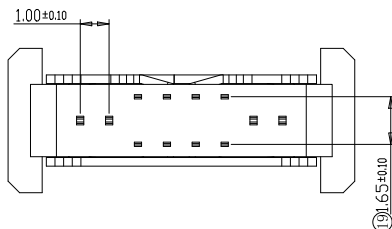
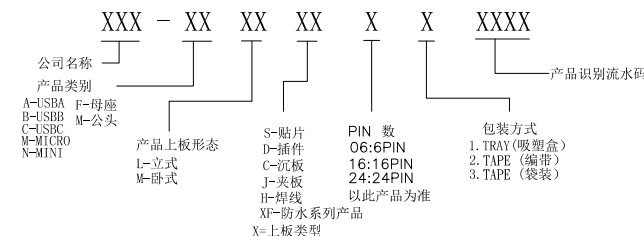

A1	GND	B12	GND
A4	VBUS	B9	VBUS
A5	CC1	B8	SBU2
A6	D+	B7	D-
A7	D-	B6	D+
A8	SBU1	B5	CC2
A9	VBUS	B4	VBUS
A12	GND	B1	GND
PIN	SIGNAL NAME	PIN	SIGNAL NAME

ZDX 深圳市兆达鑫科技有限公司
Shenzhen zhaodaxin Technology Co., Ltd

TITLE:		PART NO.: ZDX-CFLD161JS14		
TYPE-C 16PIN 180度插板母座 高H=18.5MM		TEL: 0755-29888153		
工程图		WEB: http://www.szzdjmkj.com/		
THIRD ANGLE PROJECTION	UNIT:	SCALE:	SIZE:	SHEET:
	mm	1:1	A4	1/2

RoHS Compliant

Halogen Free

customer drawing

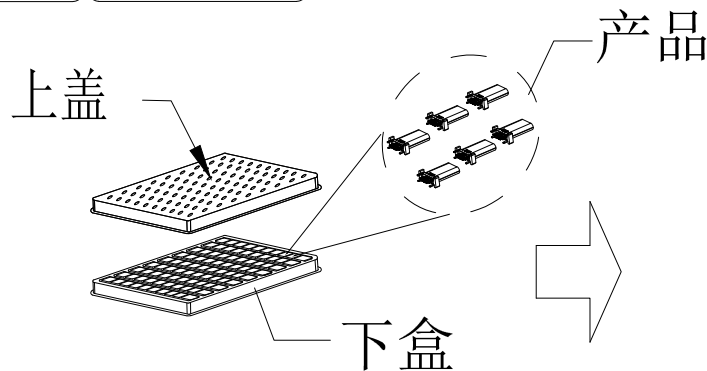

① PE真空盒(1Set).

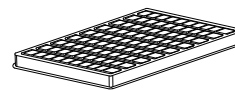

② 100Pcs/盒

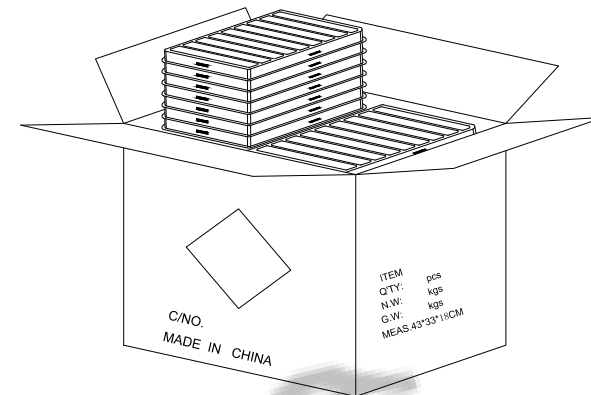

③ 50盒/箱(5k).

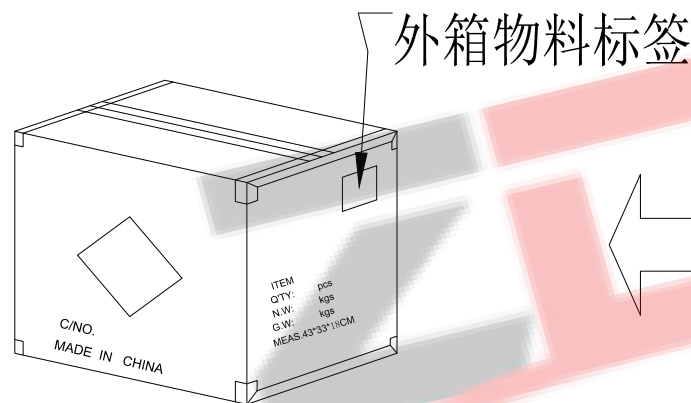

外箱物料标签

⑥ 依图示粘贴产品或ROHS标签.

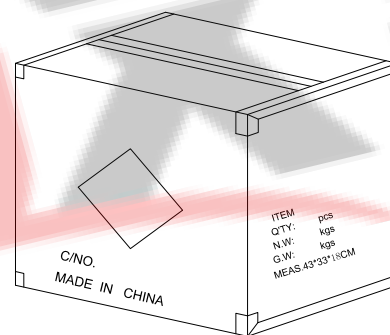

⑤ 外箱用透明胶纸带封“工”字型.

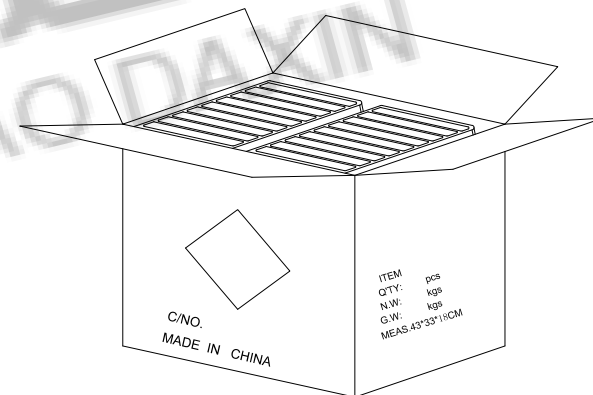

④ 每箱横放25盒*2,若尾数箱在空间处加装填充物.

备注:

1. PE真空盒1set
2. 每盒装成品100Pcs
3. 每箱数量5K
4. 外箱尺寸与规格: 43*33*18CM
5. 外箱用透明胶纸带封“工”字型;

ZDX 深圳市兆达鑫科技有限公司
Shenzhen zhaodaxin Technology Co., Ltd

TITLE:		PART NO.:ZDX-CFLD161JS14		
TYPE-C 16PIN 180度插板母座 高H=18.5MM		TEL:0755-29888153		
工程图		WEB: http://www.szzdjmkj.com/		
THIRD ANGLE PROJECTION	UNIT:	SCALE:	SIZE:	SHEET:
	mm	1:1	A4	2/2