

剖视图

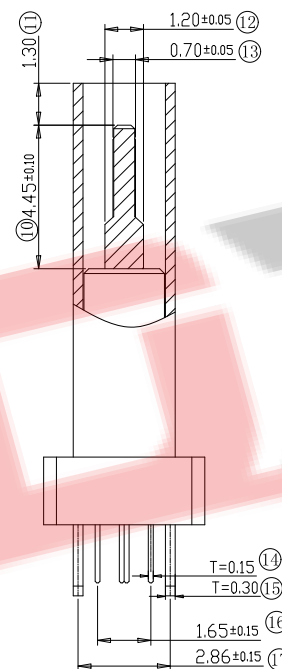

剖视图

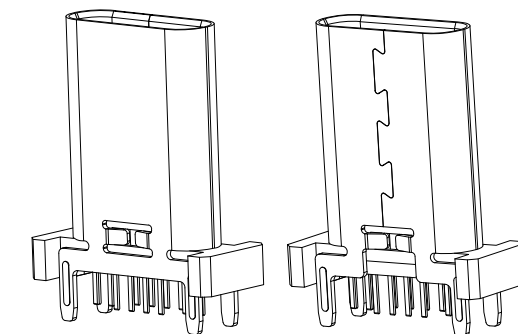
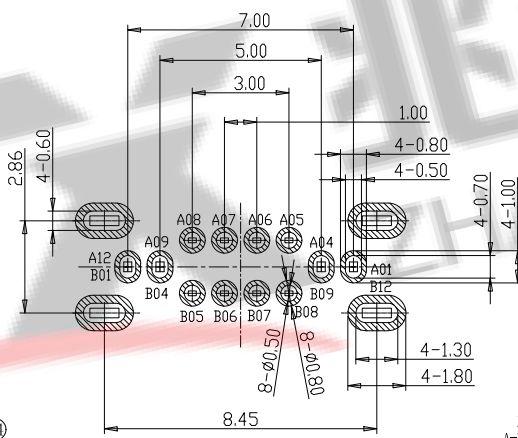

RECOMMENDED P.C.B. LAYOUT (T:1.00mm)  
TOLERANCE UNSPECIFIED ±0.05mm

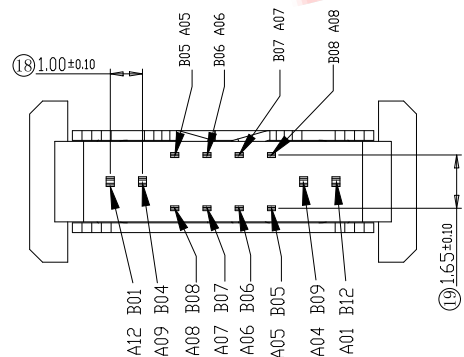

A1	GND	B12	GND
A4	VBUS	B9	VBUS
A5	CC1	B8	SBU2
A6	D+	B7	D-
A7	D-	B6	D+
A8	SBU1	B5	CC2
A9	VBUS	B4	VBUS
A12	GND	B1	GND
PIN	SIGNAL NAME	PIN	SIGNAL NAME

特性:

- 一、电气性能: ELECTRICAL
  1. 额定电流: 5.0A
  2. 接触阻抗: 40 MILLIOHMS MAX
  3. 耐电压: 150V AC / 1 mA MAX
  4. 绝缘阻抗: 150V DC/100 MEGA OHMS MIN
- 二、机械性能:
  1. 插入力: 5~20N
  2. 拨出力: 8~20N
  3. 使用寿命: 10000次、拨出力 5N MIN
- 三、材料: MATERIAL
  1. 塑胶: LCP/PA9T UL94V-0
  2. 端子: C7025/C1814 T=0.15MM
  3. 外壳: SUS304 T=0.30MM
  4. 卡勾: SUS304 T=0.15MM
- 四、电镀: FINISH
  1. 端子: 接触点镀金3U~MIN  
PIN脚焊接区域镀金1U~MIN.
  2. 外壳: 镀镍80U~MIN (盐雾48H)
- 五、电镀品需做粘锡测试: 粘锡面积达到95%以上。
- 六、SMT回流焊 (峰值260° C±5° C) 不能起泡、熔胶、变色不良 (变形在公差范围以内)
- 七、工作温度: -55° C~+85° C
- 八、盐雾测试: 通过48H在浓度为5±1%盐水的盐雾测试无生锈现象

料号编码:

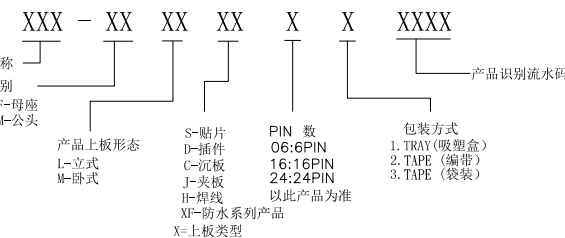

**ZDX** 深圳市兆达鑫科技有限公司  
Shenzhen zhaodaxin Technology Co., Ltd

TITLE:		PART NO.:ZDX-CFLD161JS11		
TYPE-C 16PIN 180度插板母座 高H=13.7MM		TEL:0755-29888153		
工程图		WEB: http://www.szzdjmj.com/		
THIRD ANGLE PROJECTION	UNIT:	SCALE:	SIZE:	SHEET:
	mm	1:1	A4	1/2

RoHS Compliant

Halogen Free

customer drawing

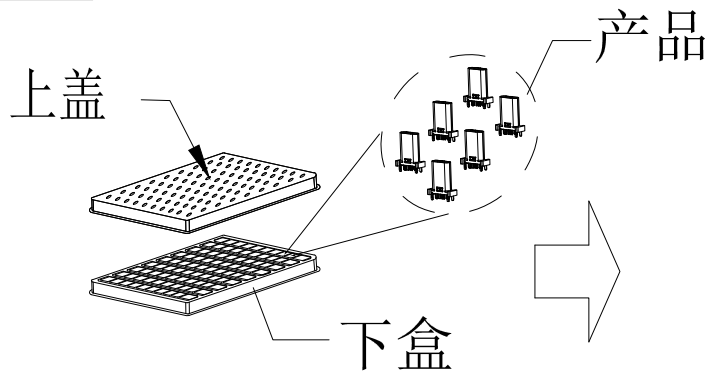

① PE真空盒 (1Set).

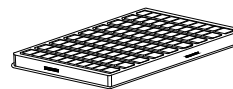

② 100Pcs/盒

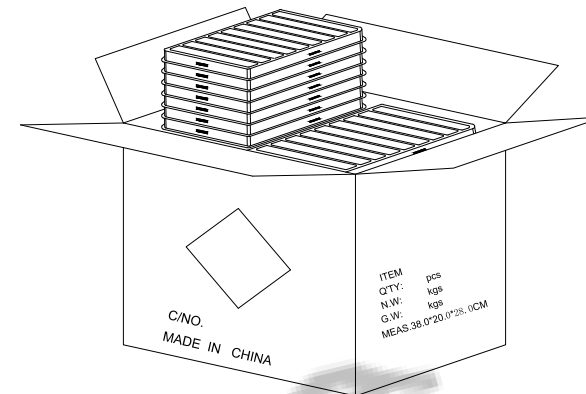

③ 40盒/箱 (4k).

外箱物料标签

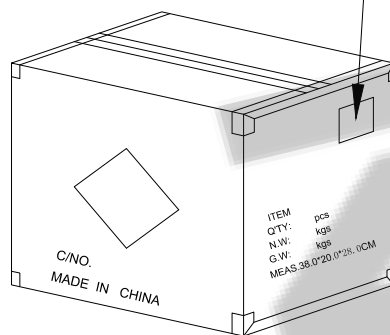

⑥ 依图示粘贴产品或ROHS标签.

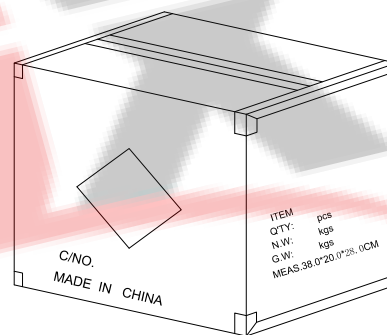

⑤ 外箱用透明胶纸带封“工”字型.

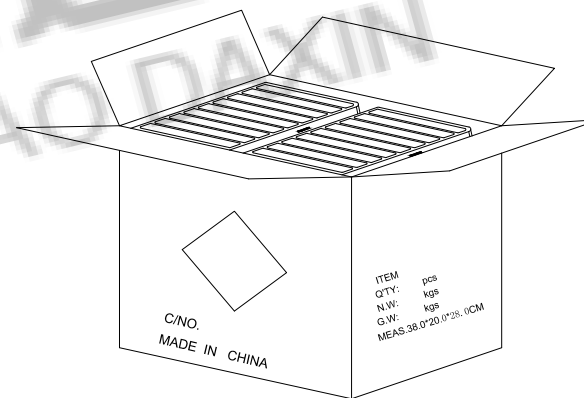

④ 每箱竖放20盒\*2, 若尾数箱在空间处加装填充物.

备注:

1. PE真空盒1set
2. 每盒装成品100Pcs, 四周并用订书机装订;
3. 每箱数量见表一
4. 外箱尺寸与规格: 38\*20\*28CM
5. 外箱用透明胶纸带封“工”字型;



深圳市兆达鑫科技有限公司

Shenzhen zhaodaxin Technology Co., Ltd

TITLE:		PART NO.:ZDC-CFLD161JS11		
TYPE-C 16PIN 180度插板母座 高H=13.7MM		TEL:0755-29888153		
工程图		WEB: http://www.szzdjmj.com/		
THIRD ANGLE PROJECTION	UNIT:	SCALE:	SIZE:	SHEET:
	mm	1:1	A4	2/2