

RoHS Compliant

Halogen Free

CUSTOMER DRAWING

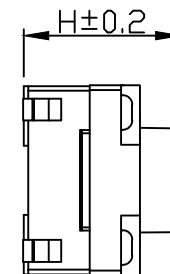
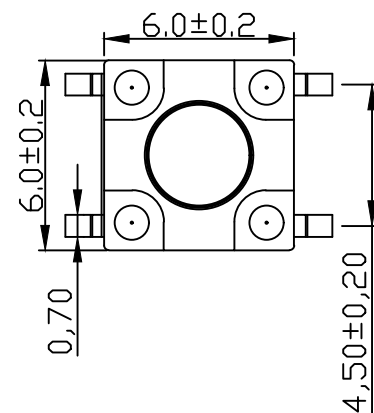
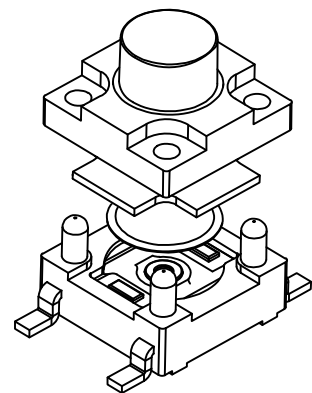

H	
4.3	4.5
4.8	5.0
5.5	6.0
6.5	7.0
7.5	8.0
8.5	9.0
9.5	10.0
10.5	11.0

主要技术规格:

1. 额定值: 50mA DC12V
2. 接触电阻: $\leq 50m\Omega$
3. 操作力: $160\&250 \pm 50gf$
4. 行程: $0.3 \pm 0.1mm$
5. 绝缘电阻: $\geq 100M\Omega$
6. 抗电强度: 250V 50HZ 1Min.
7. 寿命: 100,000 Cycles
8. 防水等级: IP67
9. 防银迁移: 60V, 85°C, 90%RH/60H

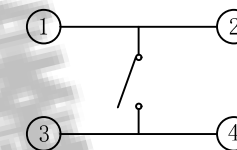
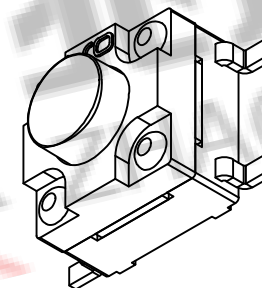
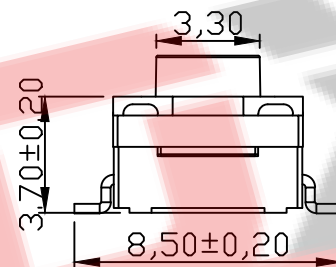

电路图

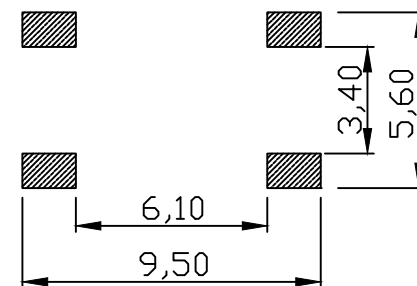

PCB. 焊接图

第一视角

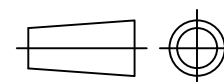

ZDX 深圳市兆达鑫科技有限公司
Shenzhen zhaodaxin Technology Co., Ltd

TITLE: 轻触开关

PART NO.: R002-H0001

型号: 6*6防水贴片3.7 (8.5)

MODEL:

工程图

WEB: <http://www.szzdjmj.com/>

THIRD ANGLE PROJECTION

UNIT:

SCALE:

SIZE:

SHEET:

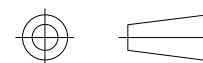

mm

1:1

A4

1/2

1	按钮	PPA	耐温280°C (黑色)						
2	盖板	PPA	耐温280°C (黑色)						
3	防水垫	硅胶(0.3mm)	耐温280°C (黑色)	标记	处数	更改文件号	签名	日期	
4	簧片	不锈钢	覆银	设计		刘志强		2016.05.10	
5	基座	PPA	耐温280°C (黑色)	审核		黄少煌		2016.05.10	
序号	零件名称	材料规格	数量	备注	批准	李泽毅		2016.05.12	