

RoHS Compliant

Halogen Free

CUSTOMER DRAWING

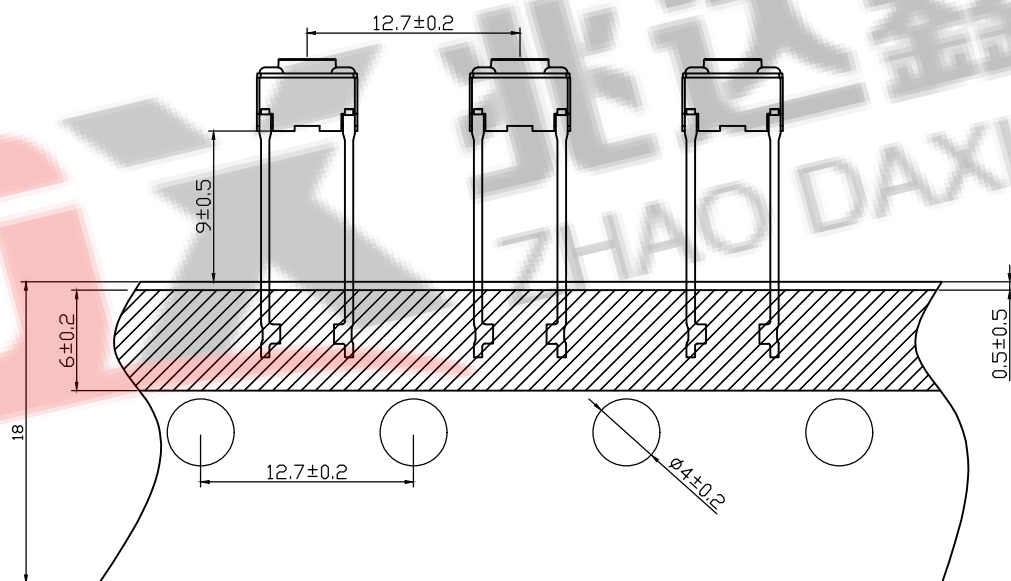
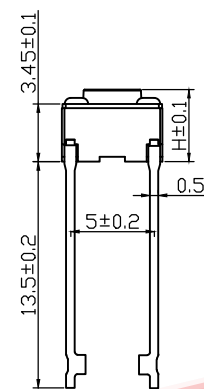
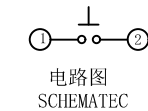
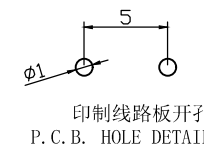
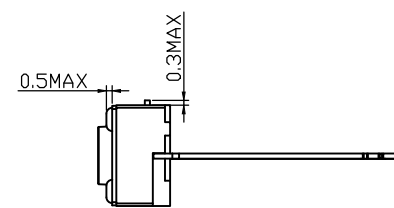
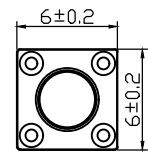
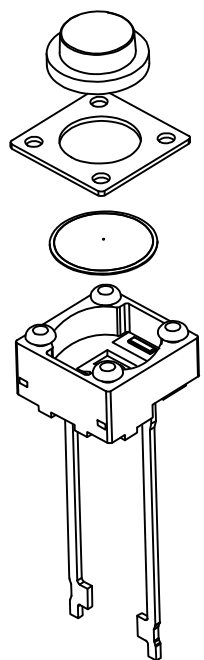

H	
4.3	4.5
5.0	5.5
6.0	6.5
7.0	7.5
8.0	8.5
9.0	9.5
10.0	

主要技术规格:

1. 额定值: 50mA DC12V
2. 接触电阻: $\leq 50m\Omega$
3. 操作力: $250 \pm 40gf$
4. 行程: $0.25 \pm 0.1mm$
5. 绝缘电阻: $\geq 100M\Omega$
6. 抗电强度: 250V 50HZ 1Min.
7. 寿命: 100,000 Cycles

第一视角

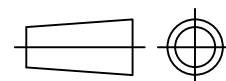

ZDX 深圳市兆达鑫科技有限公司
Shenzhen zhaodaxin Technology Co., Ltd

TITLE: 轻触开关
型号: 6*6中二脚编带

PART NO.: K024-H0001

MODEL:

WEB: <http://www.szzdjmkj.com/>

工程图

THIRD ANGLE PROJECTION

UNIT:

SCALE:

SIZE:

SHEET:

mm

1:1

A4

1/2

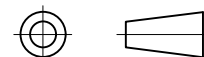

5	引脚、触点	黄铜	1	镀银					
4	基座	PPA	1	耐温280℃ (黑色)					
3	簧片	不锈钢	1	覆银	标记	处数	更改文件号	签名	日期
2	盖板	冷轧钢&黄铜	1	镀镍	设计		刘志强		2016.05.10
1	按钮	PPA	1	耐温280℃ (黑色)	审核		黄少煌		2016.05.10
序号	零件名称	材料规格	数量	备注	批准		李泽毅		2016.05.12