

RoHS Compliant

Halogen Free

CUSTOMER DRAWING

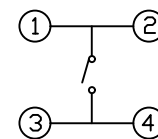
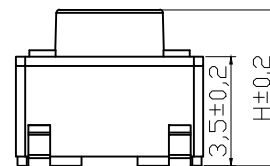
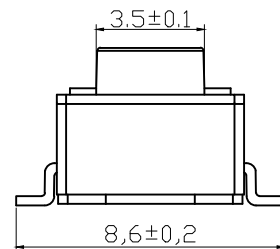
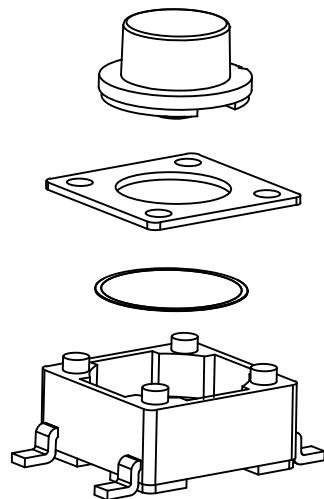

电路图

H	
4.3	4.5
5.0	5.5
6.0	6.5
7.0	7.5
8.0	8.5
9.0	9.5
10.0	10.5
11.0	12.0

主要技术规格:

1. 额定值: 50mA DC12V
2. 接触电阻:  $\leq 50m\Omega$
3. 操作力:  $250 \pm 40gf$
4. 行程:  $0.25 \pm 0.1mm$
5. 绝缘电阻:  $\geq 100M\Omega$
6. 抗电强度: 250V 50HZ 1Min.
7. 寿命: 100,000 Cycles

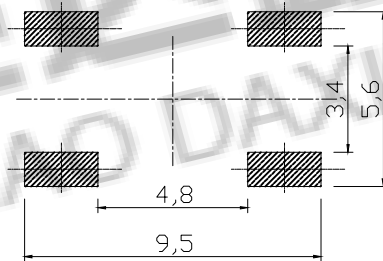
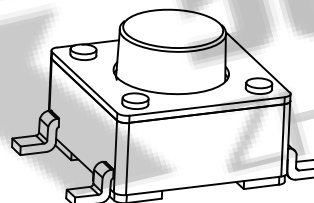
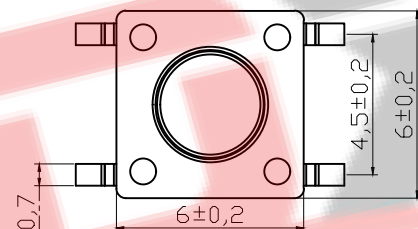

PCB. 焊接图

第一视角

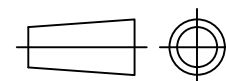

**ZDX** 深圳市兆达鑫科技有限公司  
Shenzhen zhaodaxin Technology Co., Ltd

TITLE: 轻触开关  
型号: 6\*6-SMD 8.6脚距

PART NO.: K005-H0001

MODEL:  
WEB: <http://www.szzdjmj.com/>

工程图

THIRD ANGLE PROJECTION

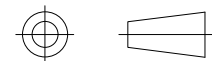

UNIT:	SCALE:	SIZE:	SHEET:
mm	1:1	A4	1/2

序号	零件名称	材料规格	数量	备注	批准	李泽毅	2016.05.12
1	按钮	PPA	1	耐温280℃ (黑色)	审核	黄少煌	2016.05.10
2	盖板	冷轧钢	1	/	设计	刘志强	2016.05.10
3	簧片	不锈钢	1	覆银	标记	处数	更改文件号
4	基座	PPA	1	耐温280℃ (黑色)			
5	引脚、触点	黄铜	1	镀银			

RoHS Compliant

Halogen Free

CUSTOMER DRAWING

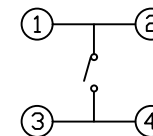
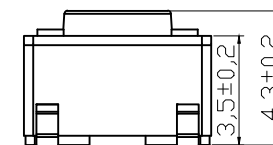
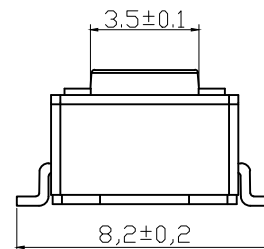
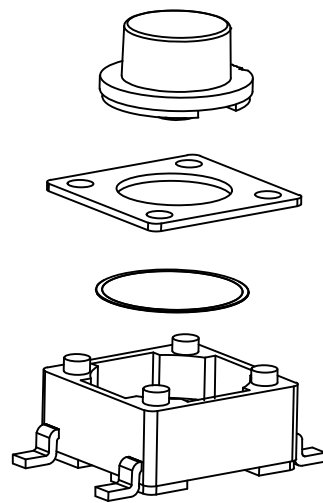

电路图

主要技术规格:

1. 额定值: 50mA DC12V
2. 接触电阻:  $\leq 50m\Omega$
3. 操作力:  $250 \pm 40gf$
4. 行程:  $0.25 \pm 0.1mm$
5. 绝缘电阻:  $\geq 100M\Omega$
6. 抗电强度: 250V 50HZ 1Min.
7. 寿命: 200,000 Cycles

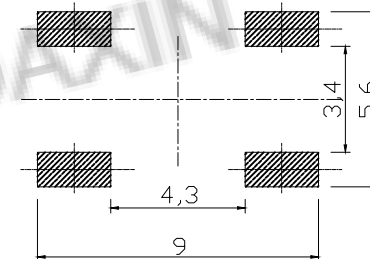
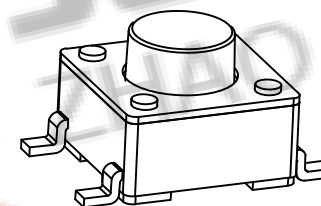
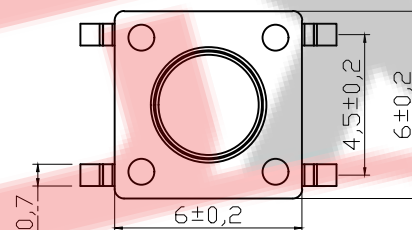

PCB. 焊接图

第一视角

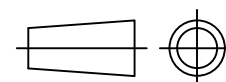

**ZDX** 深圳市兆达鑫科技有限公司  
Shenzhen zhaodaxin Technology Co., Ltd

TITLE: 轻触开关

PART NO.: K005-H0001

型号: 6\*6-SMD 8.3脚距

MODEL:

工程图

WEB: <http://www.szzdjmkj.com/>

THIRD ANGLE PROJECTION

UNIT:

SCALE:

SIZE:

SHEET:

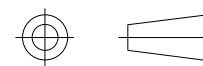

mm

1:1

A4

1/2

5	引脚、触点	黄铜	1	镀银					
4	基座	PPA	1	耐温280℃ (黑色)					
3	簧片	不锈钢	1	覆银	标记	处数	更改文件号	签名	日期
2	盖板	冷轧钢	1	/	设计		刘志强		2016.05.10
1	按钮	PPA	1	耐温280℃ (黑色)	审核		黄少煌		2016.05.10
序号	零件名称	材料规格	数量	备注	批准		李泽毅		2016.05.12