

RoHS Compliant

Halogen Free

CUSTOMER DRAWING

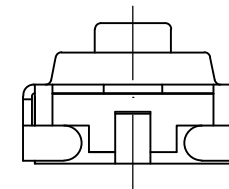
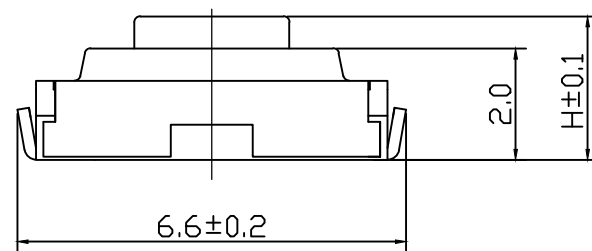
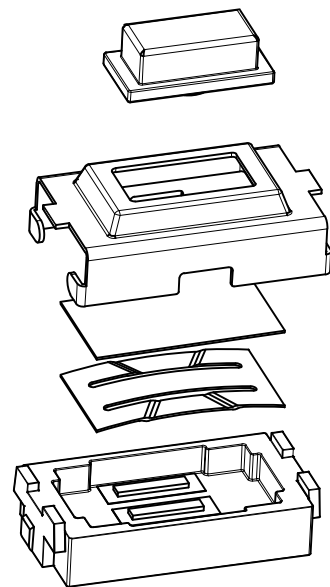

H
2.5
2.7
3.0
3.3
3.5

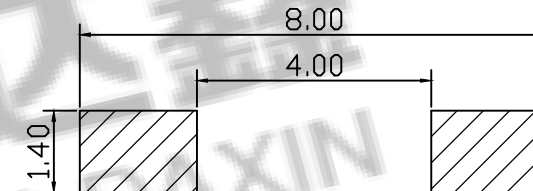
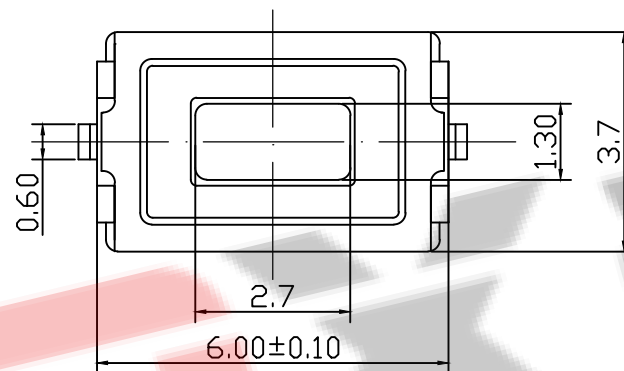

PCB. 焊接图

主要技术规格:

1. 额定值: 50mA DC12V
2. 接触电阻: ≤100mΩ
3. 操作力: 200±50gf
4. 行程: 0.20±0.1mm
5. 绝缘电阻: ≥100MΩ
6. 抗电强度: 250V 50HZ 1Min.
7. 寿命: 50,000 Cycles

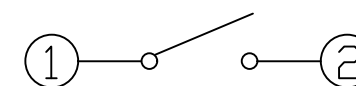
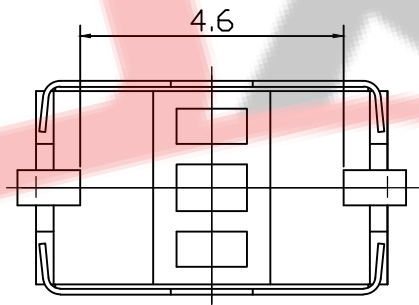

电路图

6	引脚、触点	黄铜	1	镀银						
5	基座	LCP	1	耐温280℃						
4	防尘膜	PI	1	耐温280℃ (黄色)						
3	簧片	不锈钢	1	覆银	标记	处数	更改文件号	签名	日期	
2	盖板	不锈钢	1	/	设计		刘志强		2016.05.10	
1	按钮	PPA	1	耐温280℃	审核		黄少煌		2016.05.10	
	序号	零件名称	材料规格	数量	备注	批准	李泽毅		2016.05.12	

第一视角

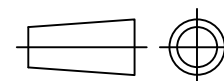

ZDX 深圳市兆达鑫科技有限公司
Shenzhen zhaodaxin Technology Co., Ltd

TITLE: 轻触开关

型号: 一型拉伸3*6U型

工程图

PART NO.: F002-H0001

MODEL:

WEB: <http://www.szzdjmj.com/>

THIRD ANGLE PROJECTION

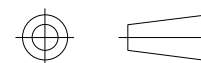

UNIT:

mm

SCALE:

1:1

SIZE:

A4

SHEET:

1/2