

RoHS Compliant

Halogen Free

CUSTOMER DRAWING

H
1.8
2.0

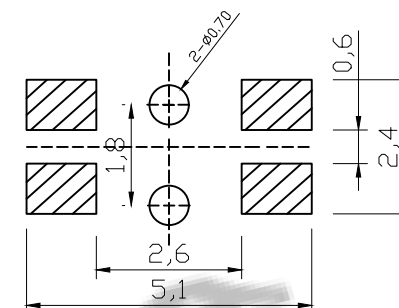
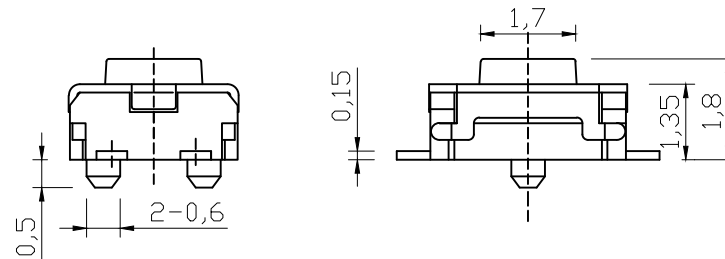
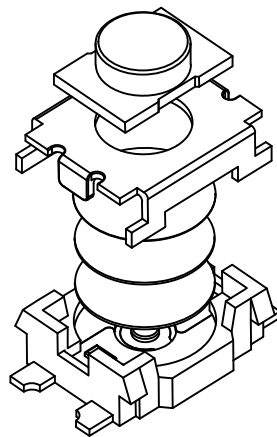

PCB. 焊接图

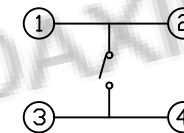
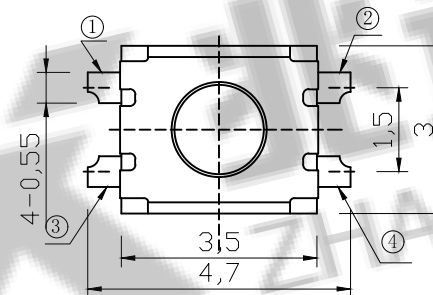
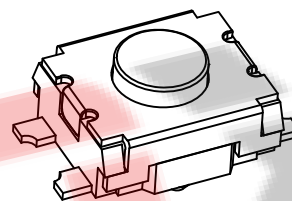

电路图

主要技术规格:

1. 额定值: 50mA DC12V
2. 接触电阻: $\leq 100m\Omega$
3. 操作力: $180 \pm 30gf$
4. 行程: $0.25 \pm 0.1mm$
5. 绝缘电阻: $\geq 100M\Omega$
6. 抗电强度: 250V 50HZ 1Min.
7. 寿命: 50,000 Cycles

第一视角

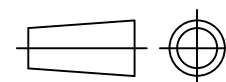

ZDX 深圳市兆达鑫科技有限公司
Shenzhen zhaodaxin Technology Co., Ltd

TITLE: 轻触开关
型号: 3*4四脚正按带柱

PART NO.: E006-H0001

MODEL:

WEB: <http://www.szzdjmj.com/>

工程图

THIRD ANGLE PROJECTION

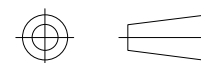

UNIT:

mm

SCALE:

1:1

SIZE:

A4

SHEET:

1/2

5	基座	LCP	1	耐温280°C (黑色)					
4	簧片	不锈钢	2	覆银					
3	防尘膜	PI	1	耐温280°C (黄色)	标记	处数	更改文件号	签名	日期
2	盖板	不锈钢	1	/	设计		刘志强		2016.05.10
1	按钮	LCP	1	耐温280°C (黑色)	审核		黄少煌		2016.05.10
序号	零件名称	材料规格	数量	备注	批准		李泽毅		2016.05.12