

RoHS Compliant

Halogen Free

CUSTOMER DRAWING

①②③④⑤⑥⑦

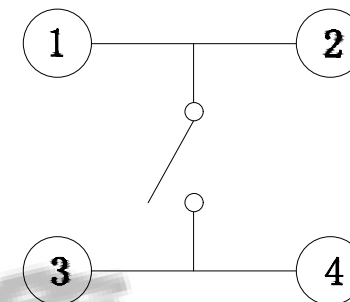
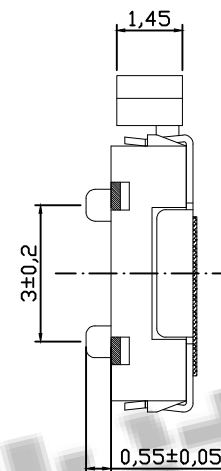
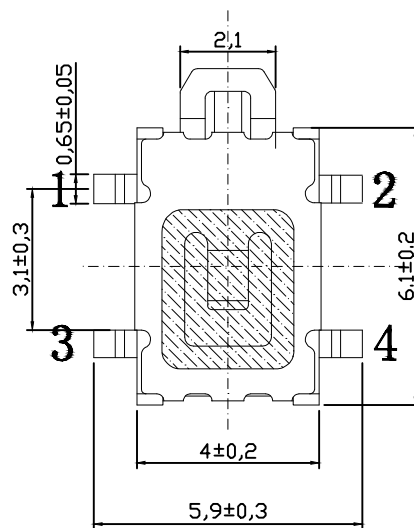
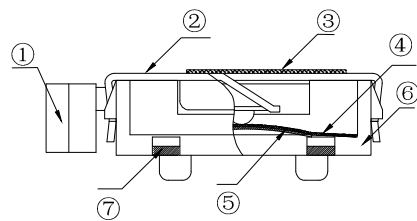

额定负荷	DC12V 50mA
绝缘强度	DC250V ≥100M Ω
耐压强度	AC250V 50Hz/1min
电气寿命	50000次/MIN
接触电阻	≤100m Ω
行程	0.25 ± 0.1mm
动作力	250 ± 50gf

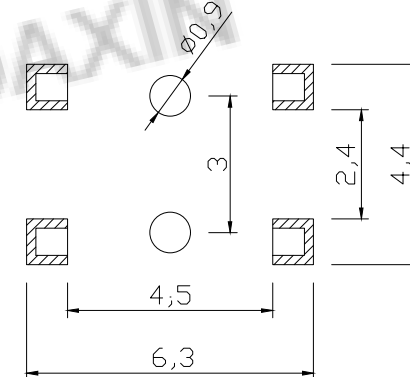
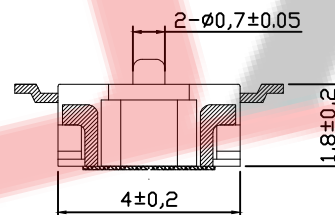

PCB. 焊接图

7	引脚、触点	磷铜	1	镀银					
6	基座	LCP	1	耐温280℃ (黑色)					
5	簧片	不锈钢	1	覆银					
4	防尘膜(内)	PI	1	耐温280℃ (黄色)					
3	防尘膜(外)	PI	1	耐温280℃ (黄色)	标记	处数	更改文件号	签名	日期
2	盖板	不锈钢	1	/	设计		刘志强		2016.05.10
1	按钮	PPA	1	耐温280℃ (黑色)	审核		黄少煌		2016.05.10
序号	零件名称	材料规格	数量	备注	批准		李泽毅		2016.05.12

第一视角

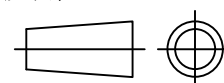

ZDX 深圳市兆达鑫科技有限公司
Shenzhen zhaodaxin Technology Co., Ltd

TITLE: 轻触开关

型号: 4*6*7H-SMD大龟老款

PART NO.: B014-H0001

MODEL:

WEB: <http://www.szzdjmj.com/>

工程图

THIRD ANGLE PROJECTION

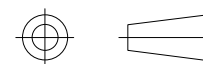

UNIT:

mm

SCALE:

1:1

SIZE:

A4

SHEET:

1/2