

RoHS Compliant

Halogen Free

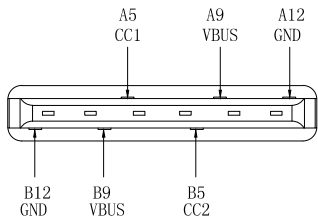
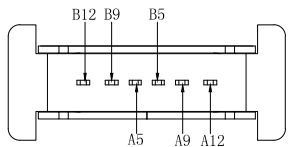
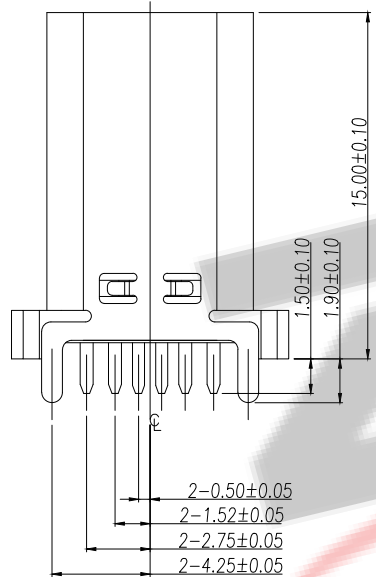
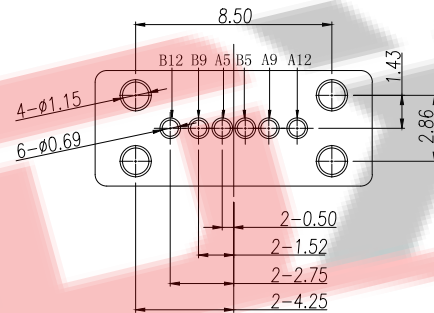
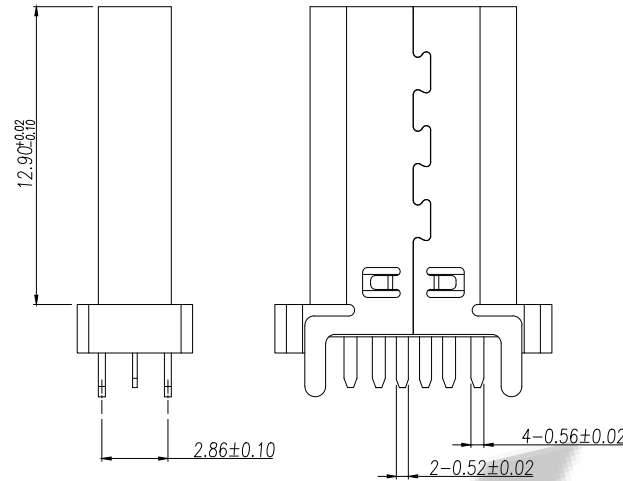
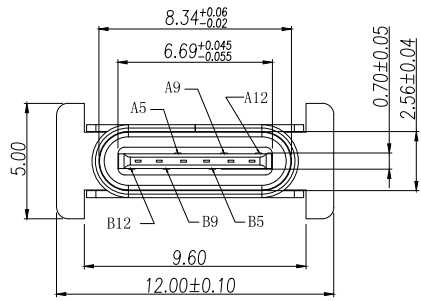

RECOMMENDED P.C.B. LAYOUT
TOLERANCE UNSPECIFIED ±0.05mm

Pin	SignalName	MatingSequence	Pin	SignalName	Mating Sequence
A1			B12	GND	First
A2			B11		
A3			B10		
A4			B9	VBUS	First
A5	CC1	Second	B8		
A6			B7		
A7			B6		
A8			B5	CC2	Second
A9	VBus	First	B4		
A10			B3		
A11			B2		
A12	GND	First	B1		
SHELL			SHELL	GND	

NOTES:

特性: Specifications

电器 Electrical:

接触阻抗: 初始最大不超过40mΩ Max, 测试后变化值不超过10mΩ Max

耐电压: AC200V 60S/MIN, 0.5mA Max: DC500V, 60S/MIN, 100ΩMax

绝缘阻抗: 100M ohms MIN

额定电流: 2A MAX

额定电压: 10V MAX

材料: Material:

Molding: LCP料黑色耐高温塑胶

端子: C2680 T=0.20mm

外壳: SUS201 T=0.30mm

电镀规格:

端子: 半金锡, 接触点镀金1u", 焊线处镀雾锡40-80u".

外壳: 镀镍80u"

环保要求: ROHS, REACH标准.

料号编码:

XXX - XX XX XX X X XXXX

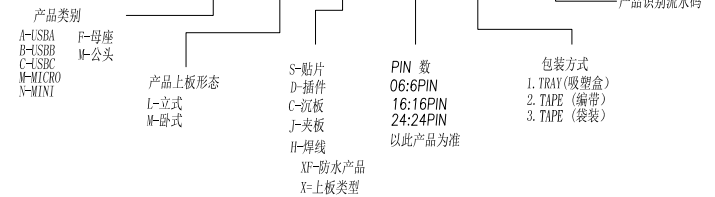

深圳市兆达鑫科技有限公司

Shenzhen zhaodaxin Technology Co., Ltd

TITLE:

6PIN TYPE C 立插母座H=15.0mm

工程图

THIRD ANGLE PROJECTION

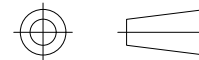

PART NO.: ZDX-CDLD63HY08

TEL: 0755-29888153

WEB: <http://www.szzdjmkj.com/>

UNIT:

mm

SCALE:

1:1

SIZE:

A4

SHEET:

1/2